

# **TABLE OF CONTENTS**

<b>1. SAFETY INFORMATION.....</b>	<b>1</b>
<b>2 PRECAUTIONS AND GENERAL RECOMMENDATIONS.....</b>	<b>3</b>
2.1 Packaging.....	3
2.2 Disposing package and scrapping used washing machines.....	3
2.3 Location and surroundings.....	3
2.4 Safety.....	3
<b>3 DESCRIPTION OF THE WASHING MACHINE .....</b>	<b>4</b>
3.1 Overview.....	4
3.2 Parts supplied.....	5
3.3 Control panel.....	5
<b>4 INSTALLATION.....</b>	<b>6</b>
4.1 Choosing an appropriate installation location.....	6
4.2 Removing the packaging and inspection.....	6
4.3 Removing the transportation bolt.....	7
4.4 Adjusting the feet.....	8
4.5 Connecting the water supply.....	9
4.6 Connecting drain hose to the drain.....	11
4.7 Electrical connection.....	12
<b>5 BEFORE THE FIRST WASH CYCLE.....</b>	<b>13</b>
<b>6 PREPARATION OF THE WASHING.....</b>	<b>13</b>
6.1 Sort the laundry.....	13
6.2 Preparing laundry for washing.....	14
6.3 Detergents and additives.....	15
<b>7 PROGRAMMES INSTRUCTIONS.....</b>	<b>18</b>
7.1 Programme table.....	18
7.2 Programmes.....	19
7.3 Heed the labels on the laundry.....	20
<b>8 PROGRAMME SETTINGS AND OPTIONS.....</b>	<b>20</b>
8.1 Add detergents, close the door and select the programme.....	20
8.2 Select any desired option.....	20
8.3 Delay End.....	21
8.4 Programme Start.....	21

- 8.5 Reload in process.....21
- 8.6 Change programme or optional function during operation.....22
- 8.7 Programme end.....22
- 8.8 Opening/closing door.....22
- 8.9 Child lock.....22
- 9 CLEANING AND MAINTENANCE.....23**
- 9.1 Removing the filter.....23
- 9.2 Draining residual water.....24
- 9.3 Care and maintenance.....24
- 10 TROUBLESHOOTING GUIDE.....25**
- 11 OPERATING DATA.....30**

## **SAFETY INFORMATION**

1. The manufacturer reserves the right for any modifications on the product which might be deemed necessary or useful without informing about it in this IFU.
2. Before operating your new washing machine, please read this instruction carefully, and keep it for future reference. If you have lost it accidentally, ask customer service for e-copy or hard copy.
3. Please make sure the socket is grounded securely, the water source connection is reliable.
4. This appliance is not to be used by persons (including children) with reduced physical, sensory or mental capabilities, or lack of experience and knowledge, unless they have been given supervision or instruction concerning use of the appliance by a person responsible for their safety.
5. This appliance can be used by children aged from 8 years and above and persons with reduced physical, sensory or mental capabilities or lack of experience and knowledge if they have been given supervision or instruction concerning use of the appliance in a safe way and understand the hazards involved. Children shall not play with the appliance. Cleaning and user maintenance shall not be made by children without supervision.
6. Children should be supervised to ensure that they do not play with the appliance.
7. If the supply cord is damaged, it must be replaced by the manufacturer, its service agent or similarly qualified persons in order to avoid a hazard.
8. The new hose-sets supplied with the appliance are to be used and that old hose-sets should not be reused.

9. For appliances with ventilation openings in the base, that a carpet must not obstruct the openings.
10. Children of less than 3 years should be kept away unless continuously supervised.
11. The maximum permissible inlet water pressure, 1 MPa, for appliances intended to be connected to the water mains. The minimum permissible inlet water pressure, 0.1 MPa, if this is necessary for the correct operation of the appliance.
12. The maximum washing capacity is 6kg.
13. For private domestic use only.
14. This appliance is intended to be used in household and similar applications such as:
  - staff kitchen areas in shops, offices and other working environments;
  - farm houses;
  - by clients in hotels, motels and other residential type environments;
  - bed and breakfast type environments;
  - areas for communal use in blocks of flats or in launderettes.

## 2 PRECAUTIONS AND GENERAL RECOMMENDATIONS

### 2.1 Packaging

- The packaging material is entirely recyclable, and marked with the recycling symbol ♻️. Adhere to current local regulations when disposing of packaging material.

### 2.2 Disposing package and scrapping used washing machines

- The washing machine is built from reusable materials. It must be disposed of in compliance with current local waste disposal regulations.
- Before scrapping, remove all detergent residues, break the door hook, and cut off the power cable so that the washing machine is made unusable.
- This appliance is marked according to the European directive on Waste Electrical and Electronic Equipment (WEEE). By ensuring that this product is disposed of correctly, you will help prevent potential negative consequences for the environment and human health, which could otherwise be caused by inappropriate waste handling of this product.



The symbol on the product, or on the documents accompanying the product indicates that this appliance may not be treated as household waste. Instead it shall be handed over to the applicable collection point for the recycling of electrical and electronic equipment. Disposal must be carried out in accordance with local environmental regulations for waste disposal. For more detailed information about treatment, recovery and recycling of this product, please contact your local city office, your household waste disposal service or the shop where you purchased the product.

### 2.3 Location and surroundings

- The washing machine must only be installed in enclosed spaces. Installation in the bathroom or other places where air is humid is not recommended.
- Do not store flammable fluids near the appliance.

### 2.4 Safety

- Do not leave the appliance plugged in when not in use. Never plug or unplug the power from the mains supply, if your hands are wet.
- Turn off the tap.
- Before any cleaning and maintenance, switch off the machine or disconnect it from the mains.

- Clean the outside of the washing machine with a damp cloth. Do not use abrasive detergents.
- Never open the door forcibly or use it as a step.
- This appliance is not intended for use by persons (including children) with reduced physical, sensory or mental capabilities, or lack of experience and knowledge, unless they have been given supervision or instruction concerning use of the appliance by a person responsible for their safety.
- Children should be supervised to ensure that they do not play with the appliance. Children must not be allowed to play with the appliance or to climb into the drum.
- If necessary, the power cable may be replaced with an identical one obtained from our After-Sales Service. The power cable must only be replaced by a qualified technician. If the product you bought has no special procedure for washing waterproof clothes such as down coat, raincoat, bicycle cover, ski pants or waterproof cover, please do not wash these articles or spin-dry them.

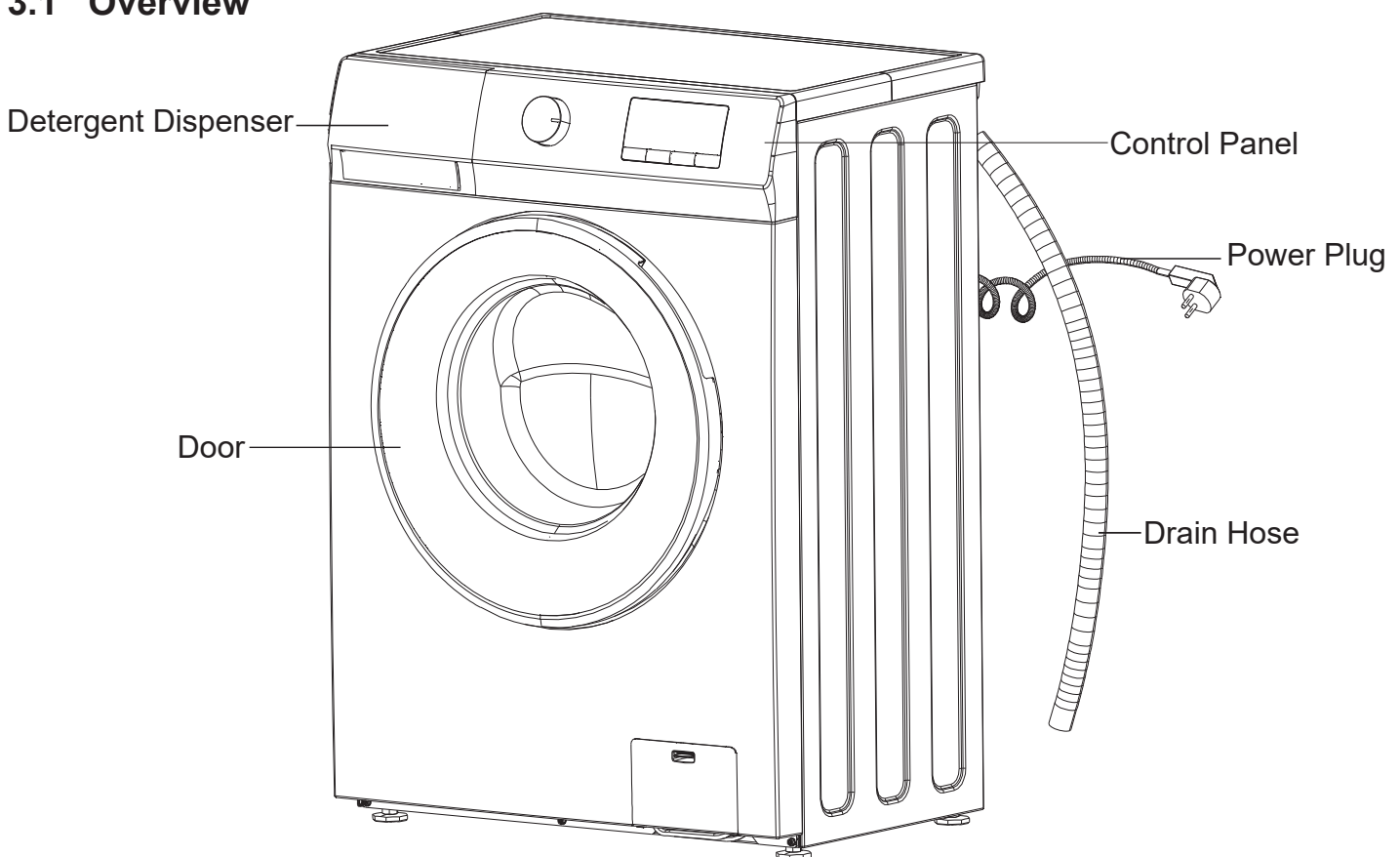

## 3 DESCRIPTION OF THE WASHING MACHINE

### 3.1 Overview

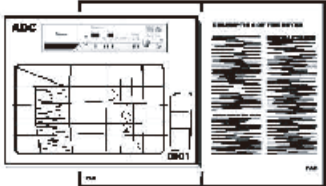
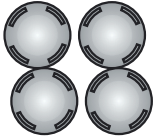

Control panel layout and appearance will depend on the model.

### 3.2 Parts supplied

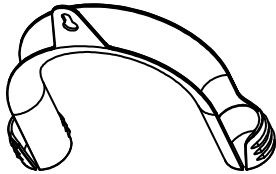
<p>User's operation Manual warranty card (depends on model)</p>	<p>4 Plastic Caps</p>
<p>(A)</p>	
<p>(B)</p>	
<p>Cold inlet hose Hot inlet hose (if available, depending on models)</p>	<p>"U" - bend</p>
<p>(C)</p>	
<p>(D)</p>	

### 3.3 Control panel

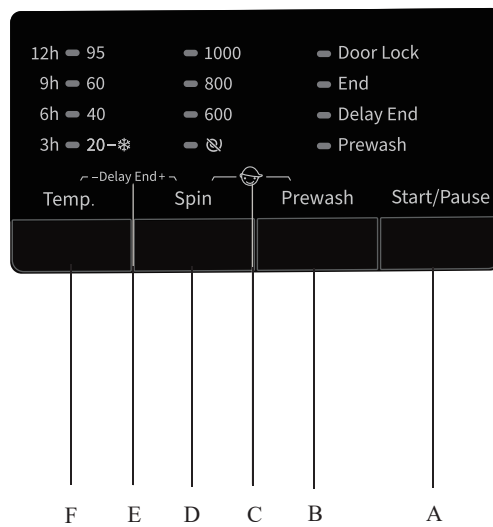
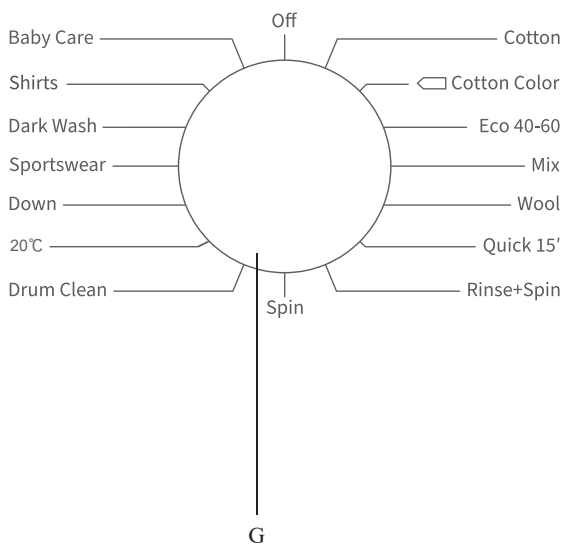

A: "Start/Pause" button

B: "Prewash" button

C: "Child lock" button

D: "Spin" button

E: "Delay End" button

F: "Temp." button

G: Programme selector

## 4 INSTALLATION

### 4.1 Choosing an appropriate installation location

#### Minimum housing dimensions:

Width: 600 mm

Height: 850 mm

Depth: refer to the Specification



Do not place the product on a floor without sufficient capacity to carry the load.  
Do not install the product in places where there is the risk of freezing.  
Move the appliance without lifting it by the worktop.

- Note:**
1. Preparation of the location and electrical, tap water and waste water installations at the place of installation is under customer's responsibility. Make sure that the installation and electrical connections of the product are performed by competent persons.
  2. Make sure that the water inlet and drain hoses as well as the power cable are not folded, pinched or crushed while pushing the product into its place after installation or cleaning procedures.
  3. The appliance must be installed on a solid and level floor surface (if necessary use a spirit level). If the appliance is to be installed on a wooden floor, distribute the weight by placing it on a 60 x 60 cm sheet of plywood at least 3 cm in thickness and secure it to the floor. If the floor is uneven, adjust the 4 leveling feet as required; do not insert pieces of wood etc. under the feet.
  4. Never place the product on a carpet-covered floor.
  5. Do not lean the product on furniture, keep a distance between them.
  6. Do not place the product on any platform.
  7. Manufacturer shall not be held liable for damages that may arise from procedures carried out by unauthorised persons.

### 4.2 Removing the packaging and inspection



**There is risk of getting injured, two or more people are needed for removing the packaging.**

After unpacking, ensure that the washing machine is undamaged. If in doubt, do not use the washing machine. Contact After-Sales Service or your local retailer

Check that the accessories and supplied parts are all present.

Keep the packaging materials (plastic bags, polystyrene parts, etc.) out of reach of children, as they are potentially dangerous.

### 4.3 Removing the transportation bolt



**Transport bolts which are not removed can cause damage to the appliance.**

The washing machine is fitted with transportation bolts to avoid any possible damage to the interior during transport.

**Step 1:** Screw off all transportation bolts for approx. 30mm with wrench following the direction of arrow shown (not fully screw it off).

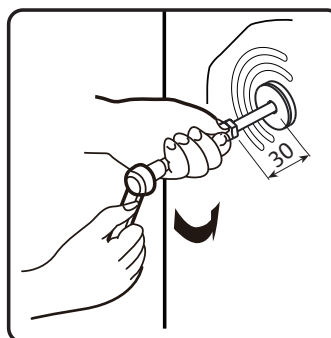
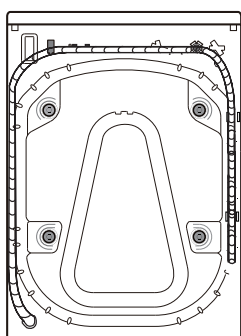

**Step 2:** Push two transportation bolts on horizontal direction inward and loose transportation bolt.

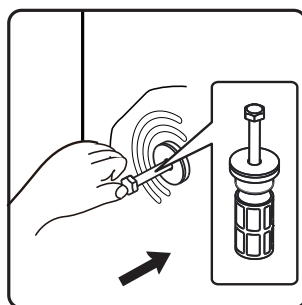

**Step 3:** Pull out transportation bolts together with rubber part and plastic part.

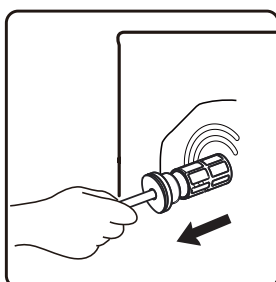

**Step 4:** To ensure safety and reduce noise, you should install the transportation bolt cover supplied with the unit (see the annex accompanying the unit). Lean and place the transportation bolt into hole and press it following the shown direction until it clicks.

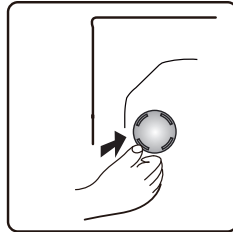

**Important:** Keep the transportation bolt for future transporting of the appliance and in this case refit the transportation bolts in reverse order.

#### 4.4 Adjusting the feet

**Step 1:** Slacken the locknut clockwise (see arrow) using the wrench.



**Step 2:** Lift the machine slightly and adjust the height of the foot by revolving it.

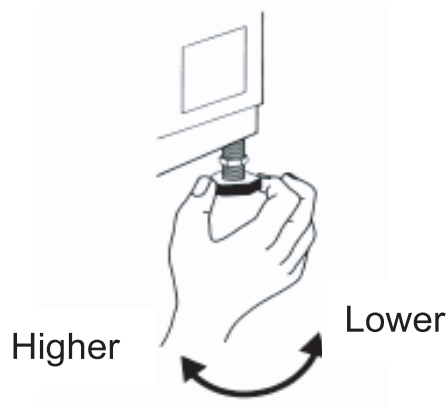

**Step 3: Important:** tighten the locknut by turning it anti-clockwise towards the appliance casing.

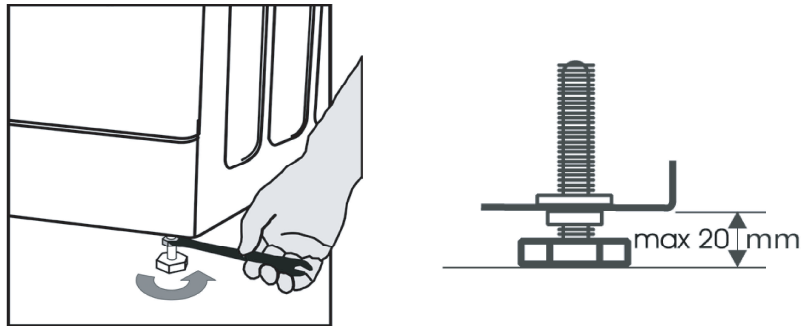

## 4.5 Connecting the water supply

- Notes:**
- Connect the water supply inlet hose in accordance with the regulations of your local water company.
  - Water tap: 3/4" threaded hose connector
  - Water pressure (flow pressure): 100-1000KPa(1-10 bar).
  - Only use a new inlet hose for connecting the washing machine to the water supply. Used hoses must not be reused. They should be discarded.

**Step 1:** If the water inlet hose is not already installed, it must be screwed to the appliance. The blue marked hose is only for cold water. Depending on the model, the hot water hose marked with red should also be connected, for models having dual inlets.

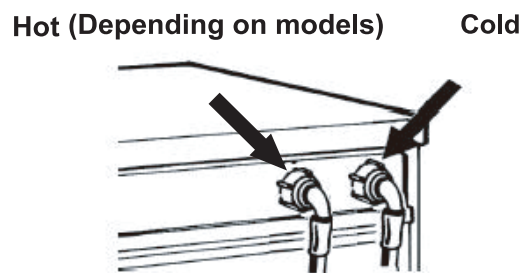

**Step 2:** Screw by hand the inlet hose onto the tap, tightening the nut.

### Attention:

- No kinks in the hose!
- The appliance must not be connected to the mixing tap of an un-pressurized water heater.
- Check water-tightness of connections by turning the tap completely on.
- If the hose is too short, replace it with suitable length of pressure resistant hose (1000 kPa min, EN 50084 approved type).

- Check the inlet hose regularly for brittleness and cracks and replace it necessary.
- The washing machine can be connected without a non-return valve.

### For Models with Single Inlet

Fix the inlet hose to the cold water tap and to the inlet valve on the rear side of the machine as Fig. 1

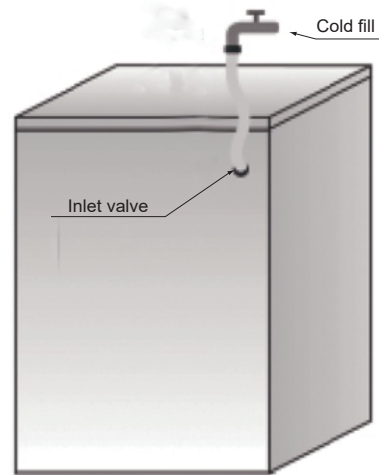
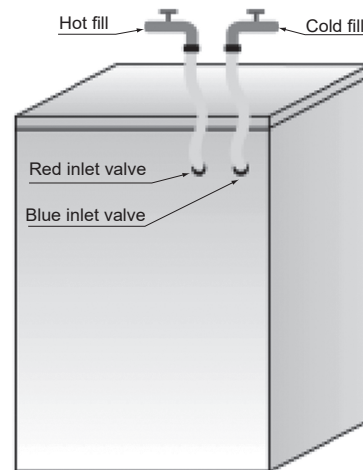

**Fig.1**

### For Models with Dual Inlets

If you wish to connect hot and cold water supply (Fig.2):

1. Fix the red marked inlet hose to the hot water tap and to the inlet valve with the red filter on the rear side of machine.
2. Fix the other inlet hose to the cold water tap and to the inlet valve with the blue filter on the rear side of the machine.



**Fig.2**

### Make sure:

1. The connections are tightly fixed
2. Do not invert their position (for example: cold fill into hot inlet valve and vice versa).

If you wish to connect only the cold fill follow the below instructions (Fig. 3):

1. You need a Y-piece connector. This can be purchased from local hardware or plumbing supplier
2. Fix the Y-piece connector to the cold fill tap.
3. Connect the two inlet valves present on the rear part of the machine to the Y-piece connector using the hoses provided.

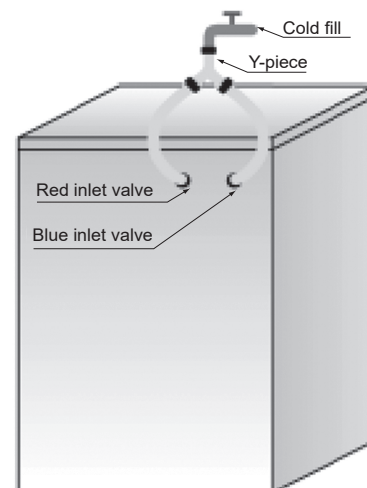

**Fig.3**

### Ensure that:

- All connections are tightly fixed.
- Do not allow children to operate, crawl on, be near or inside your washing machine.
- Note that during the wash cycles, the surface temperature of the porthole door may increase.
- Close supervision of children is necessary when the appliance is used near children.

### 4.6 Connecting drain hose to the drain

If the drain hose is installed as shown in the picture, unhook it only from the right clip (see arrow) :

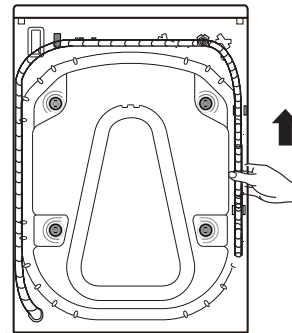

Connect the drain hose to the drain or hook it over the edge of a sink by means of the "U" bend.

Fit the "U" bend D, if not already installed, at the end of the drain hose.

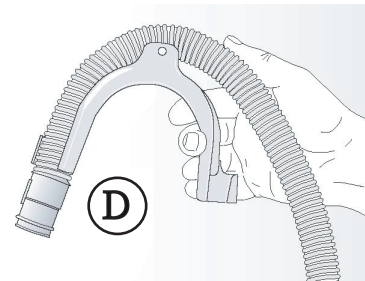

### Notes:

- If the washing machine is connected to an integrated drainage system, ensure that the latter is equipped with a vent to avoid simultaneous loading and draining of water (siphoning effect).
- Ensure that there are no kinks in the drain hose.
- Secure the hose so that it cannot fall down. After wash phase, machine will drain out hot water.
- Small hand basins are not suitable.
- To make an extension use a hose of the same type and secure the connections with clips.
- Fix the drain hose securely to prevent scalding during machine drainage.

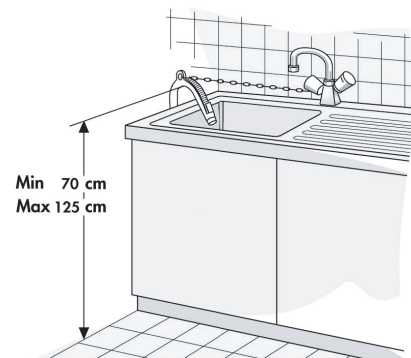

## 4.7 Electrical connection



- Electrical supply must be adequate for the machine's 16A Current Rating.
- Electrical connections must be carried out by a qualified technician in compliance with the manufacturer's instructions and current standard safety regulations.
- Electrical connections must be made in accordance with local regulations.
- The appliance must be connected to the mains by means of a socket with an earth connection in accordance with current regulations. The washing machine must be earthed by law. The manufacturer declines all liability for damage to property or injury to persons or animals due to non-compliance with the directions given above.
- Do not use extension leads or multiple sockets. Make sure the capacity of the socket is powerful enough to drive the machine during heating.

- Before any maintenance on the washing machine disconnect it from the mains supply. After installation, access to the mains plug or to disconnection from the mains supply must be ensured at all times via a double-pole switch. Do not operate the washing machine if it has been damaged during transport. Inform After-Sales Service.
- Mains cable replacement is only to be carried out by After-Sales Service. The appliance must only be used in the household for the prescribed uses.

## 5 BEFORE THE FIRST WASH CYCLE

To remove any residual water used during testing by the manufacturer, we recommend that you carry out a short wash cycle without laundry by following steps.

- 1 Open the tap.
- 2 Close the door.
- 3 Pour a little detergent (about 30 ml) into the main wash chamber  of the detergent dispenser .
4. Select and start a short programme.

## 6 PREPARATION OF THE WASHING

### 6.1 Sort the laundry

#### **By type of fabric / care label symbol**

Cottons, mixed fibres, easy care/synthetics, wool, handwash items.

#### **By colour**

Separate coloured and white items. Wash new coloured articles separately.

### **By loading**

Wash items of different sizes in the same load to improve washing efficiency and distribution in the drum.

### **By delicates**

Wash small items (e.g. nylon stockings, belts etc.) and items with hooks (e.g. bras) in a cloth bag or pillow case with zip. Always remove curtain rings or wash curtains with the rings inside a cotton bag.

## **6.2 Preparing laundry for washing**

### **a. Empty all pockets**

Coins, safety pins etc. can damage your laundry as well as the appliance drum and tub.

### **b. Fasteners**

Close zips and fasten buttons or hooks; loose belts or ribbons should be tied together.

### **c. Stain removal**

- Blood, milk, eggs etc. are generally removed by the automatic enzyme phase of the programme.
- To remove red wine, coffee, tea, grass and fruit stains etc. add a stain remover to the main wash chamber  of the detergent dispenser.
- Pre-treat heavily-soiled areas with stain remover if necessary.

### **d. Dyeing**

- Only use dyes that are suitable for washing machines.
- Follow the Manufacturer's instructions.
- Plastic and rubber parts of the washing machine can be stained by dyes.

### **e. Loading the laundry**

- Open the door.
- Load the articles one at a time loosely into the drum, without overfilling.

Observe the load sizes given in the "**Programme table**".

**Note:** Overloading the machine will result in unsatisfactory washing results and creased laundry.

- Close the door.

## 6.3 Detergents and additives

**Always use high efficiency, low foam detergent for a front load machine.**

**The choice of detergent depends on:**

- Type of fabric (cottons, easy care/synthetics, delicate items, wool)  
**Note:** Use only specific detergents for washing wool.
- Colour
- The wash temperature
- Degree and type of soiling

### **Remarks:**

Any whitish residues on dark fabrics are caused by insoluble compounds used in modern phosphate-free powder detergents. If this occurs, shake or brush out the fabric or use liquid detergents. Use only detergents and additives specifically produced for domestic washing machines. When using descaling agents, dyes or bleaches for the pre-wash, make sure that they are suitable for use in domestic washing machines. Descalers could contain products which could damage your washing machine. Do not use any solvents (e.g. turpentine, benzene). Do not machine wash fabrics that have been treated with solvents or flammable liquids.

### **Dosage**

Follow the dosage recommendations on the detergent pack. They depend on:

- Degree and type of soiling
- Size of wash  
Follow the detergent manufacturer's instructions for a full load;  
half load: 3/4 the amount used for a full load;  
minimum load (about 1 kg): 1/2 the amount used for a full load;
- Water hardness in your area (ask for information from your water company).  
Soft water requires less detergent than hard water.

### **Notes:**

Too much detergent can result in excess foam formation, which reduces washing efficiency. If the washing machine detects too much foam, it may prevent spinning.

Insufficient detergent may result in grey laundry in time and also calcifies the heating system, drum and hoses.

## Where to put detergent and additives

The detergent drawer has three chambers (fig. "A")

### Prewash chamber

- Detergent for prewash

### Mainwash chamber

- Detergent for main wash
- Stain remover
- Water softener (water hardness class 4)

### Softener chamber



- Fabric softener
- Liquid starch

Pour additives only up to the **"Max"** mark.







A

## Notes:

- Keep detergents and additives in a safe, dry place out of the reach of children.
- Liquid detergents can be used for programmes with prewash. However, in this case a powder detergent must be used for the main wash.
- Do not use liquid detergents when activating the “Delay End” function (if available on your washing machine).
- To prevent dispensing problems when using highly concentrated powder and liquid detergents, use the special detergent ball or bag supplied with the detergent and place it directly inside the drum.
- When using descaling agents, bleaches or dyes, make sure that they are suitable for washing machines. Descalers could contain compounds that can damage parts of your washing machine.
- Do not use any solvents in the washing machine (e.g. turpentine, benzene).
- If you use starch powder, proceed as follows:
  1. Wash your laundry using the desired wash programme.
  2. Prepare the starch solution according to the starch manufacturer’s instructions.
  3. Select the “**Rinse + Spin**” programme, reduce the speed to 800 rpm and start the programme.
  4. Pull out the detergent drawer until you can see about 3 cm of the main wash chamber  .
  5. Pour the starch solution into the main wash chamber  while the water is running into the detergent drawer.
  6. If there are starch residues in the detergent drawer when the programme has finished, clean the main wash chamber.

# 7 PROGRAMMES INSTRUCTIONS

## 7.1 Programme table

Program	Max load (kg)	Detergents			Washing Function Selection				Reload in process	Max. spin speed rpm
		Prewash 	Main wash 	Softener 	Temp.	Delay End	Prewash	Spin		
Baby Care --, 20-*, 40°C, 60°C, 95°C	3.0	*	Yes	*	*	*	*	*	*	1000
Shirts --, 20-*, 40°C, 60°C	3.0	—	Yes	*	*	*	—	*	*	800
Dark Wash --, 20-*, 40°C, 60°C	3.0	*	Yes	*	*	*	*	*	*	1000
Sportswear --, 20-*, 40°C	3.0	*	Yes	*	*	*	*	*	*	1000
Down --, 20-*, 40°C	3.0	—	Yes	*	*	*	—	*	*	600
20°C	6.0	*	Yes	*	—	*	*	*	*	1000
Drum Clean 95°C	—	—	Yes	—	—	*	—	*	*	600
Cotton --, 20-*, 40°C, 60°C, 95°C	6.0	*	Yes	*	*	*	*	*	*	1000
 Cotton Color --, 20-*, 40°C, 60°C	6.0	—	Yes	*	*	*	—	*	*	1000
ECO40-60 <sup>(1)</sup> --, 20-*, 40°C, 60°C	6.0	—	Yes	*	*	*	—	*	*	1000
Mix --, 20-*, 40°C	3.0	*	Yes	*	*	*	*	*	*	1000
Wool --, 20-*, 40°C	2.0	—	Yes	*	*	*	—	*	*	600
Quick 15' --, 20-*, 40°C	1.0	—	Yes	*	*	*	—	*	*	800
Rinse+Spin --	6.0	—	—	*	—	*	—	*	*	1000
Spin --	6.0	—	—	—	—	*	—	*	*	1000

\* : Optional    Yes: Dosing required    — : cannot be selected    --: Temperature of unheated water



























(1)Wash performance test programs are:Eco 40-60.

## 7.2 Programmes

You can follow the manufacturer's recommendations on clothing tags.

<b>Baby care</b>	Program to effectively extinguish bacteria in textiles. It is appropriate for clothes of babies who are sensitive to clothes
<b>Shirts</b>	Non-iron shirts or blouses made of cotton, linen, synthetic fibres or blended fabrics.
<b>Dark wash</b>	Dark textiles made of cotton and dark easy-care textiles
<b>Sportswear</b>	Sportswear and leisure wear made from microfibre fabrics.
<b>Down</b>	Machine-washable items stuffed with synthetic fibres, such as pillows, quilts and bedspreads; also suitable for items stuffed with down.
<b>20°C</b>	This program is suitable for cotton clothes with light stains, energy saving.
<b>Drum Clean</b>	Program to remove dirt and bacterial residue that can breed in the machine after it has been used for a period, especially when low temperature washes are used regularly.
<b>Cotton</b>	Heavily and moderately soiled cotton, or linen. For very heavily soiled items select the "Prewash" function.
 <b>Cotton Color</b>	Programme for lightly to moderately dirty laundry. The temperature can be set separately; therefore, observe the instructions indicated on the clothing. Wash the clothes worn directly on the skin at 60°C. Less heavily soiled laundry will be thoroughly cleaned at 40°C. Spinning speed can also be freely selected. Default setting is maximum spinning speed.
<b>ECO40-60</b>	Normally soiled cotton laundry.
<b>Mix</b>	Mixed loads of moderately soiled cotton and synthetic fabrics.
<b>Wool</b>	Machine washable wool. (Refer to the washing label attached to the clothing).
<b>Quick 15'</b>	Cotton, mixed fabrics. Items worn for a short time or newly bought.
<b>Rinse +Spin</b>	This program is defaulted to two rinses and spin.
<b>Spin</b>	Select the speed of the spin manually.

## 7.3: Heed the labels on the laundry.

<b>Normal wash; Sensitive laundry</b>	Max. washing temp. 95°C  	Max. washing temp. 60°C  	Max. washing temp. 40°C  	Max. washing temp. 30°C  	Hand wash only 	Do not wash 
<b>Bleaching</b>	Bleaching in cool water 			Bleaching not allowed 		
<b>Dry cleaning</b>	Dry cleaning with all agents 	Petroleum solvent R11, R113 	Dry cleaning in kerosene pure alcohol, and R113 	Dry cleaning not allowed 		
<b>Ironing</b>	Hot ironing, max. 200°C 	Hot ironing, max. 150°C 	Hot ironing, max. 110°C 	Ironing not allowed 		
<b>Drying</b>	Dry flat (place on a flat surface) 	Drip dry  Line dry 	High temperature  Low temperature 	Do not tumble dry 		

## 8 PROGRAMME SETTINGS AND OPTIONS

### 8.1 Add detergents, close the door and select the programme

Add detergent as described in the chapter 6.3 “**Detergent and Additives**” and close the door. (Please select proper non-foaming or low-foaming detergent)

1. Turn the **Programme Selector** button to the desired programme position.
2. The time display shows the duration of the chosen programme (in hours and minutes).

**Note:** The actual running time of the programme can be adjusted automatically according to washing situation and may be different from display time.

### 8.2 Select any desired option

- Press the selected option button once, and the corresponding indicator turns on.
- If the selected programme and option cannot be combined, these functions will fail to be selected automatically and indicator will turn off automatically.

## Prewash

- Suitable for heavily soiled (e.g., soil, dust). The programme is prolonged for 20 minutes.

## Spin

- The programme defaults to the partial max. spin speed.
- Press buttons to select other spin speeds.
- If spin speed “” selected, the last spin process will be canceled and the machine only dewateres before the end of programme.

## Temp.

- Each programme is corresponding to its default temperature. If needed, press “Temp.” button to adjust.

## 8.3 Delay End

- Delay End function allows to run the machine at the consumers convenience, for example, at night when electricity is cheaper.
- Select programme, temperature and options.
- In standby mode, press and hold "Temp."+"Spin" to enter or cancel the Delay end mode, press “Temp.” to reduce the reservation time, and press "Spin" to increase the reservation time. After reservation function is selected, "Temp." and "Spin" can no longer change the program slave parameters. Each time the key is pressed, time changes for 3 hour.Reservation time is 3 to 12 hours.After reservation is set, if other parameters such as temperature, rotating speed or function are adjusted, reservation will be cancelled. When rotating the knob to change program, reservation will be cancelled.Reservation time is the time when it ends, i.e. washing time is included, so reservation time must be more than washing time.
- The Delay End indicator light stays on when the programme starts.
- When the time counts down to the total wash time, the Delay End indicator light turns off and the washing starts.
- To cancel **Delay End**, turn programme selector to another programme position, before pressing “**Start/Pause**” button.

## 8.4 Programme Start

- Switch on and select programme required and corresponding function keys, then press the “**Start/Pause**” button to run the programme.

## 8.5 Reload in process

Press “**Start/Pause**” button to reload clothes in the process of washing.

- If the door can be opened in the process, door lock indicator light will flashes. Until door lock indicator turns off, you can open the door to load clothes.

- If the door lock indicator doesn't flash, it indicates that current temperature is over 50°C or you have passed the time for reloading in the process, namely no clothes allowed to load into the machine.

## 8.6 Change programme or optional function during operation

- Turn the programme selector knob on position "OFF" for 3 seconds to turn off the machine;
- Restart the machine and select new programme and options. If needed, select spin speed.
- Re-press "**Start/Pause**" button to start new programme. Don't add detergent any more.

## 8.7 Programme end

The washing machine shows "**End**" at the end of the program, when the door is unlocked. If the knob is turned to "**Off**", the power will be cut off. If there is no button or knob operation within 2 minutes, the program will automatically power off .

- Turn the programme selector knob on position "Off" for 3 seconds to turn off the machine;
- Close the tap;
- Open the door and take the washed clothes out;
- Slightly open the door to remove moisture in the tube.

## 8.8 Opening/closing door

- After the procedure ends, the "End" indicator is on and the door lock indicator light goes out. At this time, the door can be opened.
- If the door needs to be opened, press "**Start/Pause**" button, and if the door lock indicator light flashes, it shows that the unlocking condition is met; in 2 minutes, the door lock indicator goes out, and at this time, the door can be opened; if the door lock indicator does not flash, it shows that the unlocking condition is not met; under such situation, if the door needs to be opened, turn the programme selector knob on position "OFF" for 3 seconds to turn off the machine and restart the washing machine; select "**Spin**" procedure, and set the spin speed as "🌀". After the procedure operation ends, door lock indicator goes out, and at this time, the door can be opened.
- Never open the door forcibly while the machine is running, otherwise you can damage the door lock.
- To open the door, hold the door handle and pull the door. Close the door by pressing it without excessive force until it clicks shut.

## 8.9 Child lock

### Child lock

To strengthen the safety of children, the machine is equipped with "**Child Lock**" function.

- When the programme starts, press "**spin + prewash**" button simultaneously, the "prewash" indicator light and "🌀" indicator light is on then **Child Lock** is set up;
- When the child lock is set, all function buttons will be shielded;
- When the programme starts, press "**spin+ prewash**" button simultaneously, the "prewash" indicator light and "🌀" indicator light is on then Child Lock is released;
- When power is shut down, child lock is released.

## 9 CLEANING AND MAINTENANCE

### 9.1 Removing the filter

We recommend that you check and clean the filter regularly, at least two or three times a year.



#### Especially:

- If the appliance is not draining properly or if it fails to perform spin cycles.
- If the pump is blocked by a foreign body (e.g. buttons coins or safety pins).

**IMPORTANT: Ensure that the water has cooled before draining the appliance.**

1. Stop the appliance and unplug it.
2. Depending on the model, remove the plinth by holding it tightly on both sides, pushing it downward and tilting it to the front. Or, push down on the tabs provided on both the sides and remove it.
3. Place a container beneath it.
4. Open the filter but do not remove it completely. Slowly turn the filter counterclockwise until the water begins to drain out.
5. Wait until all the water has drained.
6. Now unscrew the filter completely and remove it.
7. Clean the filter and the filter chamber.
8. Check that the pump rotor moves freely.
9. Re-insert the filter and screw it in clockwise as far as it will go.
10. Reinstall the plinth.
11. Plug in the appliance once again.
12. Select a programme and start it.

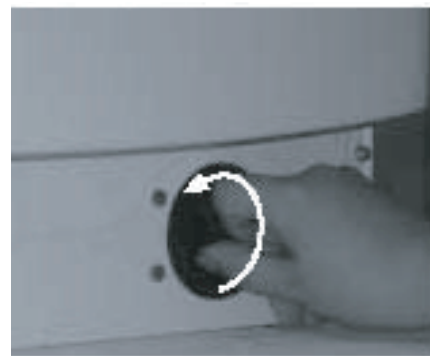

## 9.2 Draining residual water

**Before emptying the residual water, switch the appliance off and unplug it from the mains socket. Remove the plinth. Place a container beneath it.**

1. Open the filter but do not remove it completely. Slowly turn the filter counterclockwise until the water begins to drain out.
2. Wait until all the water has drained.
3. Now unscrew the filter completely and remove it.
4. Tilt the appliance forward carefully to allow the water to flow out.
5. Refit the filter and screw it in clockwise as far as it will go.
6. Refit the plinth.

## 9.3 Care and maintenance

### Appliance exterior and control panel

- Can be washed down with a soft, damp cloth.
- A little neutral detergent (non abrasive) can also be used.
- Dry with a soft cloth.

**Do not use flammable fluids for cleaning the appliance.**

### Detergent dispenser

1. Press the siphon cap in the softener compartment and remove the drawer (fig. "A").
2. Remove siphon cap from the fabric softener compartment (fig. "B").
3. Wash all the parts under running water.
4. Refit the siphon cap in the detergent drawer and fit the drawer back inside its housing.

### Filter

- Check and clean the filter regularly, at least two or three times a year (see "Removing the filter").

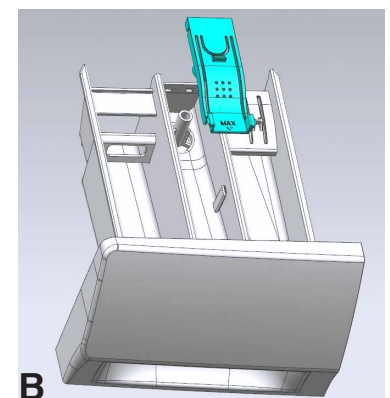
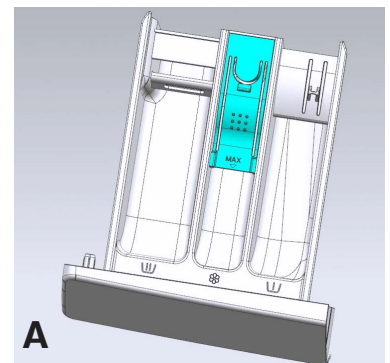

## Door seal

- Clean with a damp cloth when necessary.
- Check the condition of the door seal periodically.

## Water supply hose

Check the supply hose regularly for brittleness and cracks and replace it if necessary using a new hose of the same type (available from After-Sales Service or specialist dealer).

## Mesh filter for water connection

Check and clean regularly.

For washing machines with an inlet hose as shown on pictures .

1. Close the tap and loosen the inlet hose on the tap.
2. Clean the internal mesh filter and screw the water inlet hose back onto the tap.
3. Now unscrew the inlet hose on the rear of the washing machine.
4. Pull off the mesh filter from the washing machine connection with universal pliers and clean it.
5. Refit the mesh filter and screw the inlet hose on again.
6. Turn on the tap and ensure that the connections are completely water-tight.



## 10 TROUBLESHOOTING GUIDE

Depending on the model, your washing machine is equipped with various automatic safety functions. This enables faults to be detected in good time and the safety system can then react appropriately. These faults are frequently so minor that they can be resolved within a few minutes.

### The washing machine will not start.

Check whether:

- The mains plug is inserted into the socket.
- The wall socket is functioning correctly (use a table lamp or similar appliance to test it).
- The door is properly closed .
- The “**Start/Pause**” button has been pressed.

## **The appliance stops during the programme**

Check whether:

The door has been opened and the “**Start/Pause**” button not be pressed.

Close the door and press the “**Start/Pause**” button again.

Check if there is too much foam inside, machine enters kill-foam routine. The machine will run again automatically after a period.

The washing machine’s safety system has been activated (see “Fault description table”).

## **Residue from detergent and additives left in the detergent drawer at end of wash.**

Check whether:

- The siphon cap are correctly installed in the detergent dispenser and all parts are Clean (see “Care And Maintenance”).  
Sufficient water is entering. The mesh filters of the water supply could be
- Blocked (see “Care And Maintenance”).

## **Machine vibrates during spin cycle.**

Check whether:

- The washing machine is level and standing firmly on all four feet.
- Transportation bolts have been removed. Before using the machine, it is imperative that transportation bolts are removed.

## **Final spin results are poor.**

The washing machine has an imbalance detection and correction system. If individual heavy items are loaded (e.g. bathrobes), this system may reduce the spin speed automatically or even interrupt the spin completely if it detects too great an imbalance even after several spin starts, in order to protect the washing machine.

- If the laundry is still too wet at the end of the cycle, remove some articles of laundry and repeat the spin cycle.
- Excessive foam formation may prevent spinning. Use the correct amount of detergent.
- Check that the spin speed selector has been set to “  ”.

**Ensure that:**

All connections are tightly fixed.

Do not allow children to operate, crawl on, be near or inside your washer.

Note that during the wash cycles, the surface temperature of the porthole door may increase.

Close supervision of children is necessary when the appliance is used near children.

**Error code**

The appliance stops during the programme.

The error code will appear with some lights.

■ means the light is on; □ means the light is off .

**Door lock is abnormal(F13): The indicator will light up.(fig.1)**

Check whether the door is closed or not and press the “**start/pause**” button; if the fault persists, unplug the appliance and contact After-Sales Service (see “**After-Sales Service**”).

12h ■ 95	□ 1000	□ Door Lock
9h ■ 60	□ 800	□ End
6h ■ 40	□ 600	■ Delay End
3h ■ 20-*	■ 	■ Prewash

fig.1

**Drainage fault(F03):(fig.2)**

Waste water is not being pumped out.

The washing machine stops in the appropriate programme step.

Unplug the appliance.

Check whether:

- Kinks are present in the drain hose;
- The pump or the filter is blocked (see “Removing the Filter”).

**IMPORTANT:** Ensure that the water has cooled before draining the appliance.

- The drain hose is frozen up.

Plug in the appliance again. If the fault persists, unplug the appliance and contact After-Sales Service(see “**After-Sales Service**” ).

12h ■ 95	○ 1000	○ Door Lock
9h ■ 60	○ 800	○ End
6h ■ 40	○ 600	■ Delay End
3h ■ 20-✱	○ ☒	■ Prewash

fig.2

**Electronic module fails(F05, F04,F23,F07,F06). (fig.3,fig.4,fig.5,fig.6,fig.7)**

- Electronic module fails.

Turn the programme selector knob on position "OFF" for 3 seconds to turn off the machine and select the desired programme; if the fault persists,unplug the appliance and contact After-Sales Service (see “After-Sales Service”).

12h ■ 95	○ 1000	○ Door Lock
9h ■ 60	○ 800	■ End
6h ■ 40	○ 600	○ Delay End
3h ■ 20-✱	○ ☒	■ Prewash

fig.3 Abnormal temperature sensor

12h ■ 95	○ 1000	○ Door Lock
9h ■ 60	○ 800	■ End
6h ■ 40	○ 600	○ Delay End
3h ■ 20-✱	○ ☒	○ Prewash

fig.4 Abnormal water heater

12h ■ 95	○ 1000	○ Door Lock
9h ■ 60	○ 800	○ End
6h ■ 40	■ 600	■ Delay End
3h ■ 20-✱	○ ☒	■ Prewash

fig.5 Abnormal water level sensor

12h ■ 95	○ 1000	○ Door Lock
9h ■ 60	○ 800	■ End
6h ■ 40	○ 600	■ Delay End
3h ■ 20-✱	○ ☒	■ Prewash

fig.6 motor error

12h ■ 95	○ 1000	○ Door Lock
9h ■ 60	○ 800	■ End
6h ■ 40	○ 600	■ Delay End
3h ■ 20-✱	○ ☒	○ Prewash

fig.7 motor speed error

### Water inflow fault(F01):(fig.8)

The appliance has none or insufficient water supply.Check whether:

- The water tap is fully open and there is sufficient water supply pressure.
- Kinks are present in the water hose.
- The mesh filters of the water supply are blocked (see “Care And Maintenance” or “Mesh Filters for Water Connection”).
- The water hose is frozen up.

After the problem has been removed, restart the programme by pressing “**Start/Pause**” again; if the fault persists, unplug the appliance and contact After-Sales Service (see “**After-Sales Service**”).

12h ■ 95	○ 1000	○ Door Lock
9h ■ 60	○ 800	○ End
6h ■ 40	○ 600	○ Delay End
3h ■ 20-✱	○ ☒	■ Prewash

fig.8

### Water level reaches overflow level(F24):(fig.9)

- Water level reaches overflow level.

Press the “**start/pause**” button to cancel the failure code and start the programme; if the fault persists,unplug the appliance and contact After-Sales Service(see “**After-Sales Service**”).

12h ■ 95	○ 1000	○ Door Lock
9h ■ 60	○ 800	■ End
6h ■ 40	■ 600	○ Delay End
3h ■ 20-✱	○ ☒	○ Prewash

fig.9

### Error while unlocking the door(F14).(fig.10)

- Action: Press “Start/Pause” button. The washing machine will try to open the door. The alarm will not be removed until the door is unlocked. Or, turn the programme selector knob on position "OFF" for 3 seconds to turn off the machine and the alarm will be removed.

12h ■ 95	○ 1000	○ Door Lock
9h ■ 60	○ 800	■ End
6h ■ 40	○ 600	○ Delay End
3h ■ 20-✱	■ ☒	○ Prewash

fig.10

## AFTER-SALES SERVICE

### Before contacting After-Sales Service:

- Try to remedy the problem yourself (see “Troubleshooting Guide”).
- Restart the programme to check whether the problem has solved itself.
- If the washing machine continues to function incorrectly, call After-Sales Service.

# 11 OPERATING DATA

In accordance with delegated regulation (EU) No.2019/2014

Model	WFMC6010E/WFMC6010ES WFMC6010ET/WFVC6010E WFVC6010ES/WFVC6010ET	WFHC6010E/WFHC6010ES WFHC6010ET/WFRC6010E WFRC6010ES/WFRC6010ET
Rated Capacity	6kg	
Max. spin speed	1000 rpm	
Voltage/Frequency	220-240V ~ 50Hz	
Gross Power	1800 W	
Water Pressure	0.1 MPa - 1MPa	
Dimensions (WxDxH)	595×458×845mm	595×460×850
Net Weight	56kg	

## Programme Instructions

1. The eco 40-60 programme is able to clean normally soiled cotton laundry declared to be washable at 40 °C or 60 °C, together in the same cycle, and that this programme is used to assess the compliance with the EU ecodesign legislation.
2. The power consumption of the off-mode is 0.49W, and the left-on mode is 0.49W.
3. The most efficient programmes in terms of energy consumption are generally those that perform at lower temperatures and longer duration.
4. Loading the household washing machine up to the capacity indicated by the manufacturer for the respective programmes will contribute to energy and water savings.
5. Correct use of detergent, softeners and other additives. Do not apply excessive detergent. This may affect the washing results adversely.
6. Periodic cleaning, including optimal frequency, and limescale prevention and procedure.
7. Noise and remaining moisture content are influenced by the spinning speed: the higher the spinning speed in the spinning phase, the higher the noise and the lower the remaining moisture content.
8. The product information and QR code are reflected in the energy consumption label, the product registration information can be obtained by scanning the QR code.
9. The information of standard programmes

Program	Selected Temperature	Rated Capacity kg	Maximum temperature in drum	Program duration h:min	Energy consumption kWh/cycle	Water consumption litres/cycle	Remaining moisture content %	Maximum speed reached rpm
Eco40-60 full load	-	6	48	3:18	1,00	43	60	1000
Eco40-60 half load	-	3	37	2:36	0,60	37	61	1000
Eco40-60 1/4 load	-	1,5	25	2:36	0,28	21	61	1000
20C°	20C°	6	20	2:58	0,28	45	61	1000
Cotton	60C°	6	48	3:08	0,96	44	61	1000
Mix	40 C°	3	38	0:58	0,49	35	50	1000
Quick 15'	40 C°	1	38	0:30	0,29	13	55	800

The values given for programmes other than the eco 40-60 programme are indicative only.